

# BI-FUEL SYSTEMS

*Powered by GTI Bi-Fuel*



**HIPOWER<sup>®</sup>**

# BI-FUEL SYSTEM TECHNOLOGY

HIPOWER SYSTEMS has partnered with Altronic, LLC to incorporate the GTI Bi-Fuel System into **HIPOWER Generators** ranging from **150KW to 3MW**.



The HIPOWER Bi-Fuel Systems will be used in the **Standby Generators Range** as well as for **Prime Power & Rental Applications**.

The GTI BI-FUEL® System is an innovative technology that enables operators of heavy-duty diesel engines to substantially reduce operational costs and lower emissions by **substituting diesel fuel with lower cost, cleaner-burning natural gas**. The BI-FUEL® System is comprised of patented technologies that allow engines to safely operate on **gas percentages up to a maximum of 70% of the total fuel requi-**

**rement**. Engines converted to GTI Bi-Fuel® exhibit diesel-like performance in such critical areas as efficiency, stability and load acceptance.

A key feature of the BI-FUEL® System is its ability to switch fuel modes without interruption in engine power output. **The engine can be switched between diesel and gas automatically while maintaining speed and**



**load.** This feature gives the user the flexibility to choose between gas and diesel modes as dictated by fuel pricing, fuel availability or other operational considerations. An equally important feature of the BI-FUEL® System is its ability to **maintain engine power levels while operating in gas mode between the “continuous” and “prime” ratings of the engine.**



**Gas Regulator**

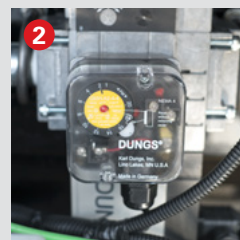

**Pressure Switch**



**Engine Control System**

## BI-FUEL SYSTEM

# OPERATION & PERFORMANCE

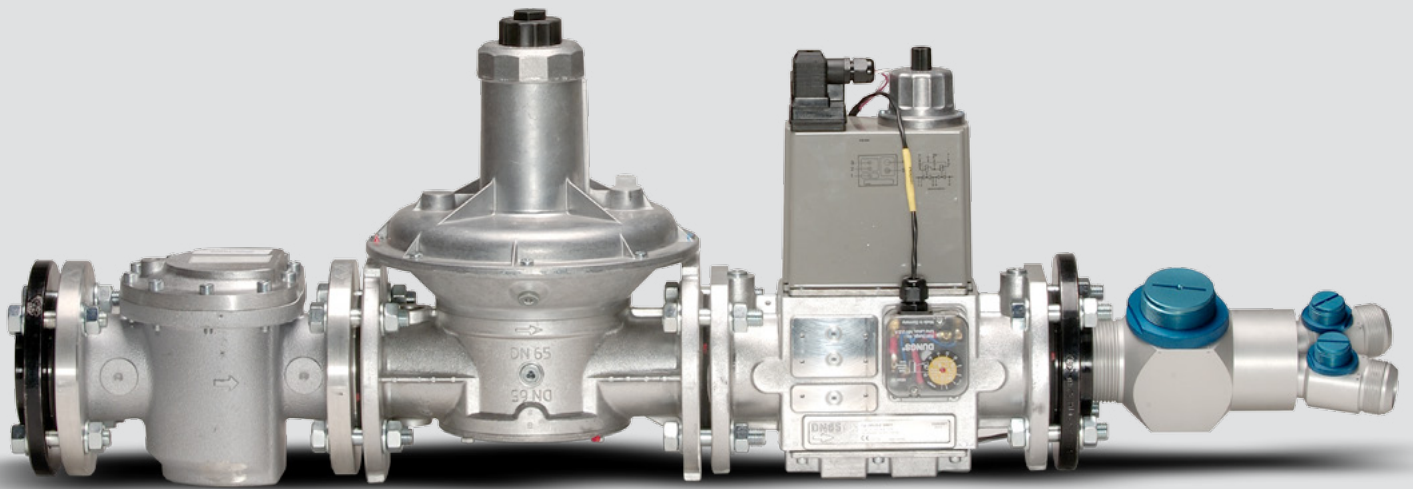

Typically, gas is introduced downstream of the engine air cleaner and upstream of the turbocharger. The gas is supplied at approximately atmospheric pressure using a proprietary air-fuel mixer that allows for a high level of gas mixing with the least possible air restriction. The air-gas mixture is compressed in the turbocharger and distributed to each cylinder by the engine air-intake manifold. The lean air-gas mixture is compressed during the compression stroke of the piston and ignited by the diesel injector. Since the air-gas mixture is maintained in a lean condition, pre-ignition does not occur.

Flow of gas to the engine is load dependent and varies with combustion airflow changes. **The BI-FUEL® System varies gas flow according to changes in engine vacuum level.** This allows it to respond to engine fuel requirements while maintaining the integrity of the OEM governing system. The standard Bi-Fuel® System incorporates a **manually-adjustable Power Valve** to control the gas substitution rate. Diesel injection is controlled by **the OEM governing system** during both gas and diesel modes.



GTI Bi-Fuel Electronic Control Panels



Gas Power Valve



New GTI+Bi-Fuel system

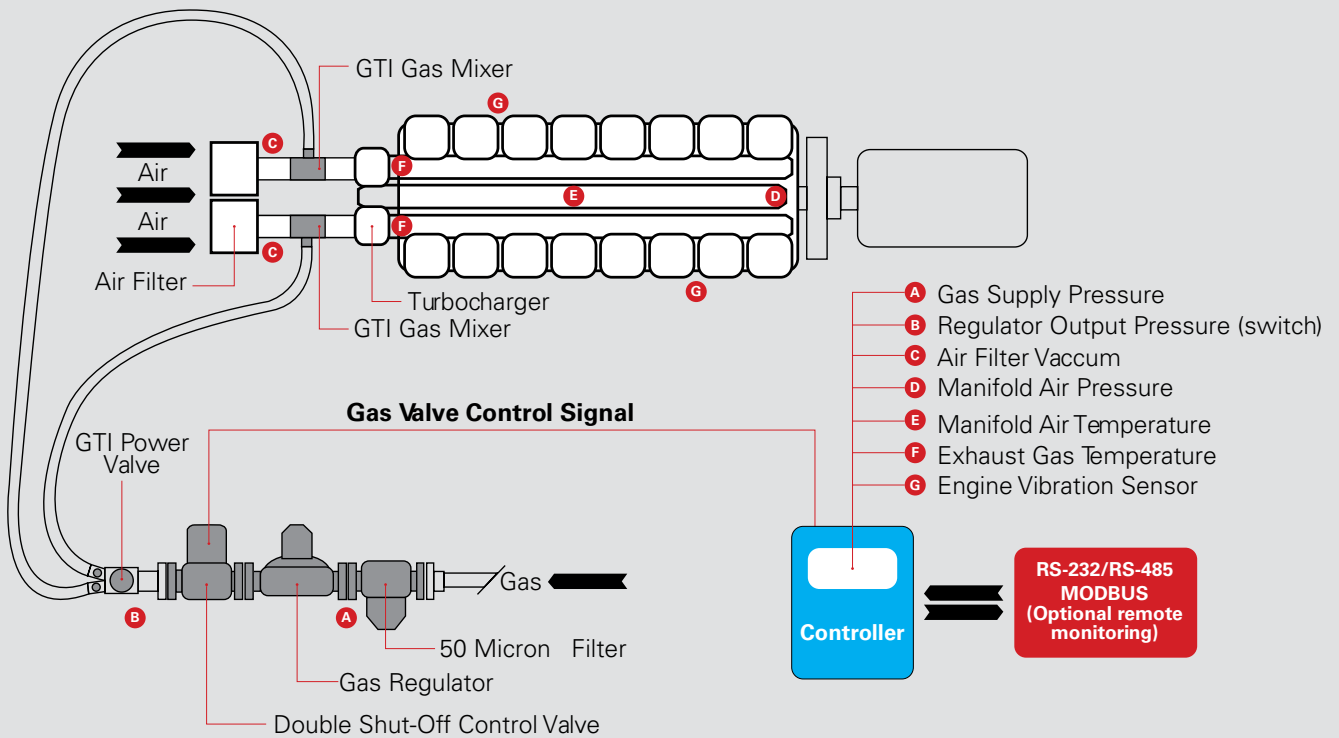

**Note:** requires isochronous diesel governor

**The Altronic DE-based BI-FUEL® Controller** monitors various engine and system parameters such as **manifold air pressure and temperature, exhaust gas temperature, intake vacuum, gas pressure and engine vibration.** This information allows the controller to determine when to activate or deactivate bi-fuel operation depending on engine performance, load level, ambient temperature, knock limits or gas supply pressure levels. The controller can communicate with remote engine monitoring systems via **RS-232/RS-485 connection (ASCII or MODBUS protocol).**

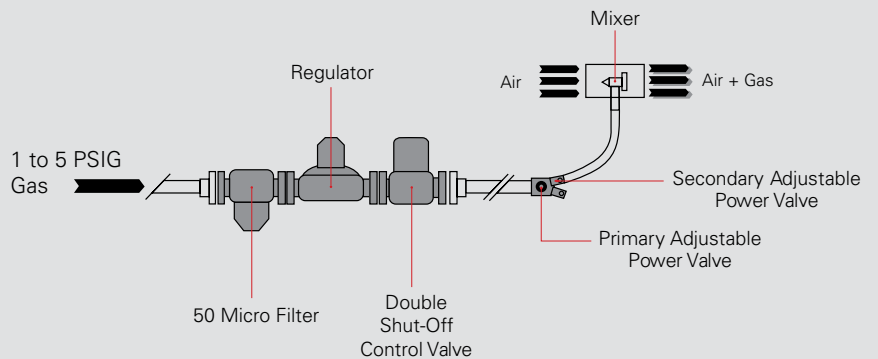

### GAS FLOW

**Engine performance during BI-FUEL® operation is on par with normal diesel levels.** Heat rejection levels to the exhaust and water jacket systems are kept within normal operating parameters. Engine response to load variation is typically equal to—or better than—100% die-

sel performance due to the unique design of the BI-FUEL® Systems and the associated combustion characteristics of the air-gas mixture. Similarly, engine load acceptance (for large block loads) meets or exceeds straight diesel performance.

# BI-FUEL SYSTEM ADVANTAGES



## Cost Savings

Displacing a percentage of diesel fuel with methane-based gas provides an immediate economic benefit based on the cost difference between the fuels and the amount of run time of the genset. In high usage gensets, the GTI system can pay for itself in a short period of time.



## Increased Run Time

Reducing the amount of diesel fuel used extends the run time in proportion to the substitution rate. This provides extra hours of operation for critical applications during extended power outages.



## Simplified Logistics

The frequency of refueling is reduced, thereby lessening the costs—and risks—associated with hauling diesel fuel, especially to locations that make such logistics awkward.



## Reduced Liquid Fuel Storage

As environmental concerns about liquid fuel storage increases pressure on operators, using the GTI Bi-Fuel® system offers some relief by reducing the volume of above-ground diesel fuel storage.



## Flare Gas Reduction

Around the world, governments and environmental concerns are increasing pressure to reduce the flaring of unwanted gases into the atmosphere. The GTI-Bi-Fuel® system allows these waste gases to be used as fuel for the generation of electrical power.



## Flexible Fuel Rates

Many gas suppliers offer discounted rates to customers who can tolerate supply interruptions in times of high demand/inadequate supply. GTI Bi-Fuel® offers this kind of flexibility since the genset can operate on 100% diesel at any time.

# BI-FUEL Kit Applications & Contents

GTI Series	Engine Power Rating	Engine Type	Gas Train Kit	Gas Mixers	GTI Series N°.	Vibration Sensor(s)	STEPCON Option	CSA Certified**
25*	Up to 75 kWe	In-line engine	1" NPT	1 x 3"	2513-OE	NA	NA	No
	75-150 kWe	In-line engine	1" NPT	1 x 4"	2514-1E	NA	NA	No
					2514-1A	Opt. (1)	NA	No
50	75-150 kWe	In-line engine	1" NPT	1 x 4"	5014-OE	NA	NA	No
					5014-1A	Opt. (1)	NA	Yes
	150-300 kWe	In-line engine	DN50 / 2" NPT	1 x 5"	5015-OE	NA	NA	No
					5015-1A	Opt. (1)	NA	Yes
65	300-600 kWe	In-line or V-engine, com. manifold	DN65 / 2.5" NPT	1 x 6"	6516-1B	Std. (2)	Optional	Yes
		V-engine	DN65 / 2.5" NPT	2 x 6"	6526-1B			
	600-1200 kWe	V-engine, common manifold	DN65 / 2.5" NPT	2 x 6"	6526-2B	Std. (2)	Optional	Yes
					6546-2B			
		V-engine, dual manifold	DN65 / 2.5" NPT	2 x 6"	6526-2C			
					6546-2C			
		V-engine, quad manifold	DN65 / 2.5" NPT	2 x 6"	6526-2D			
					6546-2D			
80	1200-3000 kWe	V-engine, common manifold	DN80 / 3" NPT	2 x 7"	8027-2B	Std. (2)	Optional	Yes
				4 x 6"	8046-2B			
				4 x 7"	8047-2B			
		V-engine, dual manifold	DN80 / 3" NPT	2 x 7"	8027-2C			
				4 x 6"	8046-2C			
				4 x 7"	8047-2C			
		V-engine, quad manifold	DN80 / 3" NPT	2 x 7"	8027-2D			
				4 x 6"	8046-2D			
				4 x 7"	8047-2D			
				4 x 7"	8047-2D			

\* Series 25 kits require 12Vdc Power; all other Series require 24 Vdc power.

\*\* CSA CERTIFIED CLASS I. DIV. 2. GROUP D Svsten available - contact HIPOWER sales office for details.

## Engine Performance

As shown below, conversion to GTI Bi-Fuel typically results in similar performance levels in terms of engine stability, response and block load capability:

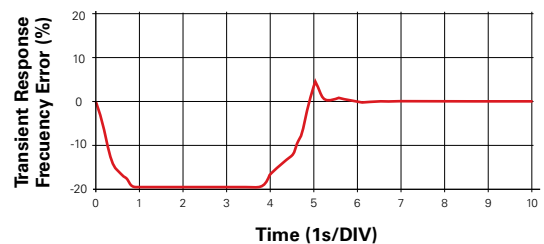
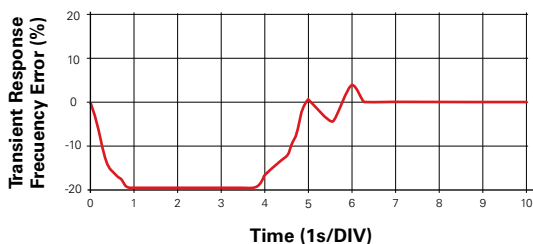
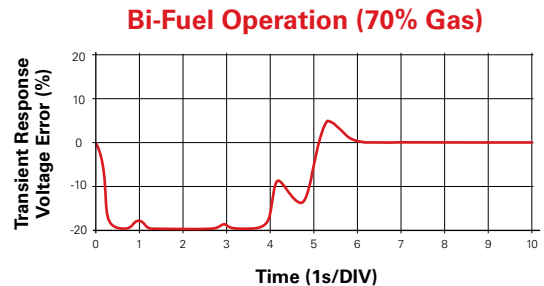
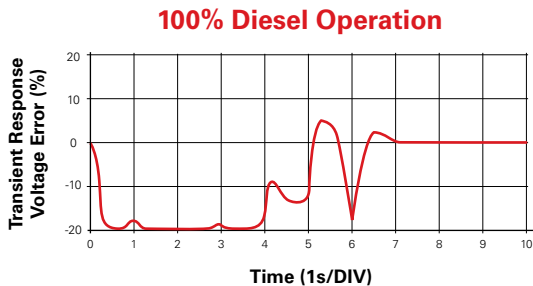

**Typical Responses to 100% Block Load Application**

# WE GOT YOUR BACK

HIPOWER is committed to customer satisfaction throughout the life of our products. Our qualified team of professionals take great pride in ensuring client satisfaction if issues arise. Our 24/7 response commitment eliminates costly downtime for you and your customer. Whatever the time or place, you can count on HIPOWER

to provide superior product support on all of our products. We offer on-site product support throughout North America, as well as factory and site specific training for our diverse product line. We constantly evaluate ourselves, and make necessary changes, in an effort to create a best-in-class product support program.



Packaged in the US



## HIMOINSA POWER SYSTEMS, INC.

16002 West 110 th Street

Lenexa, KS 662 19-1312

Tel: 913-495-5557 | Fax: 913-495-5575

Call us (toll free) at: 1 866 710-2988

[www.hipowersystems.com](http://www.hipowersystems.com)

[www.hipowersolutions.com](http://www.hipowersolutions.com)



# HIPOWER®