

# STAMFORD®

## Fitting Instructions

Heater for P0/P1 Alternators.

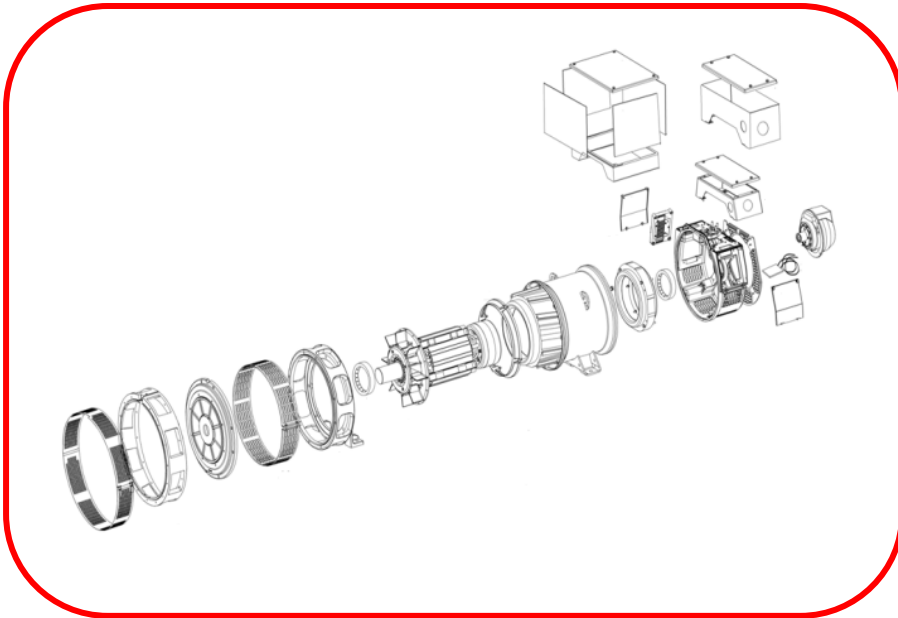

For use with the following parts kits:

- 45-1161 P0/1 HEATER KIT 230 VOLT
- 45-1162 P0/1 HEATER KIT 115 VOLT
- 45-1163 P0/1 HEATER KIT 24 VOLT
- 45-1164 P0/1 HEATER KIT 12 VOLT

# SAFETY PRECAUTIONS

Test procedures recommended in this manual assume that the reader is fully conversant with electrical safety principles, and is familiar with the operation of the various test instruments.

DO NOT attempt to work on live equipment if you are not qualified or experienced in this work.

Before testing the generating set, read the generating set Installation Manual, and this Fault Finding Manual, and become familiar with it and the equipment.

**SAFE AND EFFICIENT OPERATION CAN ONLY BE ACHIEVED IF THE EQUIPMENT IS CORRECTLY INSTALLED, OPERATED AND MAINTAINED.**

Many accidents occur because of a failure to follow fundamental rules and precautions.

**ELECTRICAL SHOCK CAN CAUSE SEVERE PERSONAL INJURY OR DEATH.**

- Ensure installation meets all applicable safety and local electrical codes. Have all installations performed by qualified Installation technicians.
- Do not operate the generator with protective covers, access covers or terminal box covers removed.
- Disable engine starting circuits before carrying out maintenance.
- Disable closing circuits and/or place warning notices on any circuit breakers normally used for connection to the mains or other generators, to avoid accidental closure.

Observe all IMPORTANT, CAUTION, WARNING, and DANGER notices, defined as:

**Important! Important refers to hazard or unsafe method or practice, which can result in product damage or related equipment damage.**

**Caution!** Caution refers to hazard or unsafe method or practice, which can result in product damage or personal injury.



**Warning !**

Warning refers to a hazard or unsafe method or practice, which CAN result in severe personal injury or possible death.



**Danger !**

Danger refers to immediate hazards, which WILL result in severe personal injury or death.

## **Introduction**

Anti-condensation (AC) heaters are recommended for all applications where the generator will be shut down for long periods, or the environment has a high humidity.

Typical applications where AC Heaters are essential are:-

1. Standby duty, when the generator is stationary.
2. High humidity conditions, where heavy condensation can gather inside a cooling generator after shutdown.
3. Marine conditions (close to coast or offshore, where a saline atmosphere can deposit salt crystals on the generator windings).
4. During storage if the environment is not maintained to prevent condensation

The 'best practice' is to connect the heaters so that they are energised when the motor is shut down.

In areas of very high humidity additional measures may be necessary to prevent condensation from forming on the windings.

Before starting the generating set, carry out pre-running insulation checks to ensure that the insulation of the windings is above 1 Megohm, if not dry the generator out.

If condensation or other moisture is seen to be present on the winding dry the machine out and check that the insulation values are good before starting the generating set.

Consult the generator manual for drying out procedures.

**Warning Isolate the generating set both mechanically and electrically before removing the covers on the generator. THINK SAFETY**

### **Note:**

Due to our policy of continuous improvement, details in this manual which were correct at time of printing may now be due for amendment. Information included must not therefore be regarded as binding.

Secure the heater to the bottom of the NDE (Non Drive End) bracket using 2 off M5X16 Hex head screws with spring washers and plain washers.

Fit the heater leads with a 200mm length of 8mm Systaflex sleeving.



Secure the harness from the heater to the coil around the periphery of the exciter stator using a temperature resistant tie.

*Note; this is critical due to the proximity of the rotor and risk of chaffing if the leads are not secured correctly.*

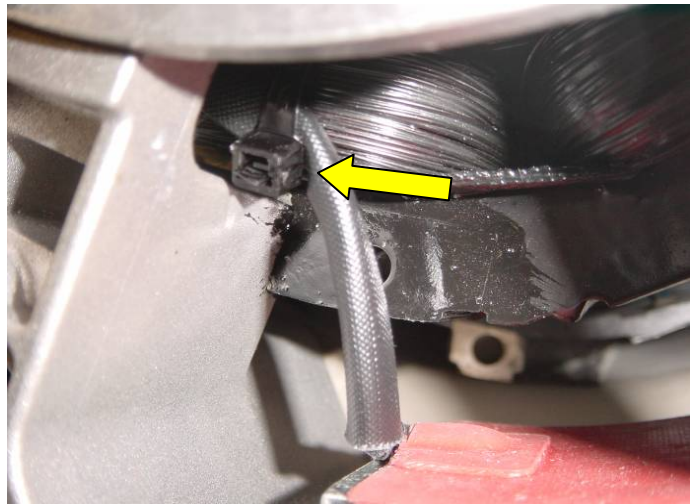

Secure the remaining harness to each individual coil around the periphery of exciter stator using temperature resistant ties

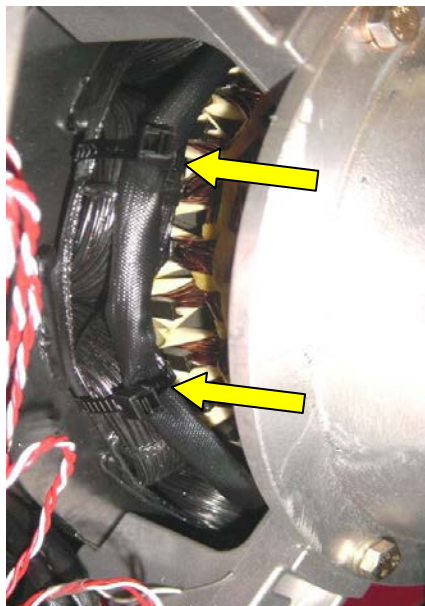

The cable which is now tied around the periphery of the exciter stator then exits at the 11.00 o'clock position.

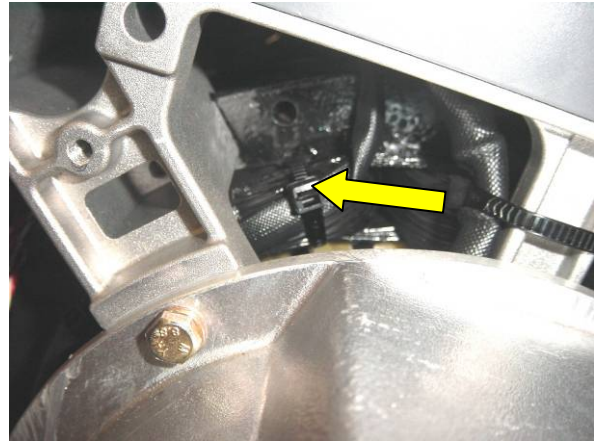

Pass the harness through the aperture in top of the NDE bracket, route it across to the grommet in the terminal box.

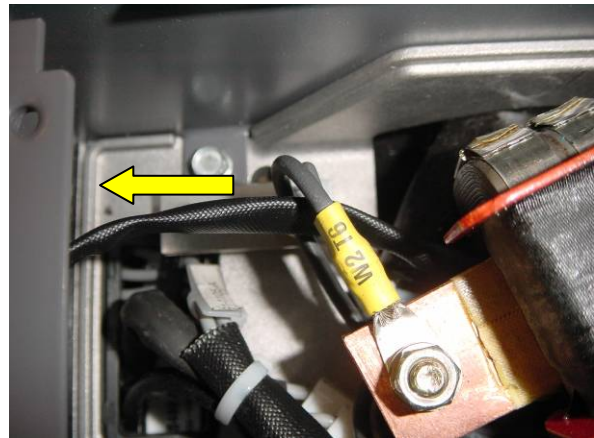

Remove the knockout in appropriate end of terminal box by gently hitting the disc, 90 degrees from the securing tab with a hammer. Hit each side in turn to loosen the pre-cut portion and produce a rocking motion to fatigue the locating tabs under the disc so it may be removed.

Drill two 5.5mm holes in the end face to enable fitting of the heater connection box.



Fit the grommet to the hole in the heater connection box and secure the assembly to the terminal box using 2 off M5X12 hex head screws, spring washers and plain washers.

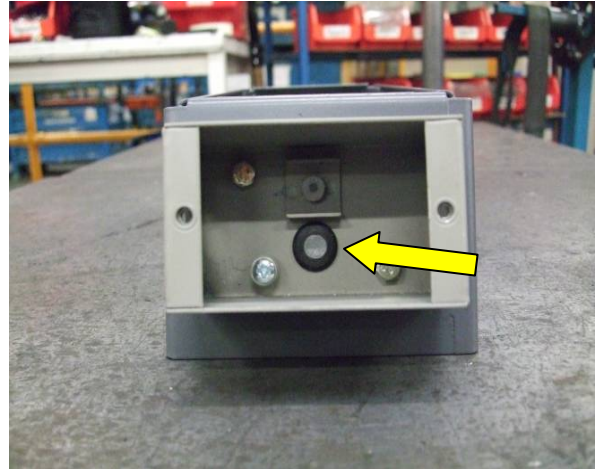

Feed the heater leads through grommet.

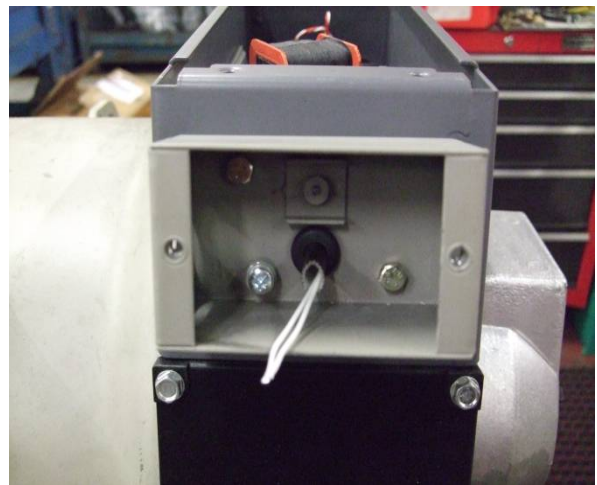

Trim the Systaflex sleeve so that it is 15mm proud of the grommet. Secure a cable tie around the Systaflex to ensure that it cannot be pulled back into the terminal box. Next, trim the leads so that they are 30mm proud of the end of the Systaflex and strip 5mm insulation from the end of each lead.

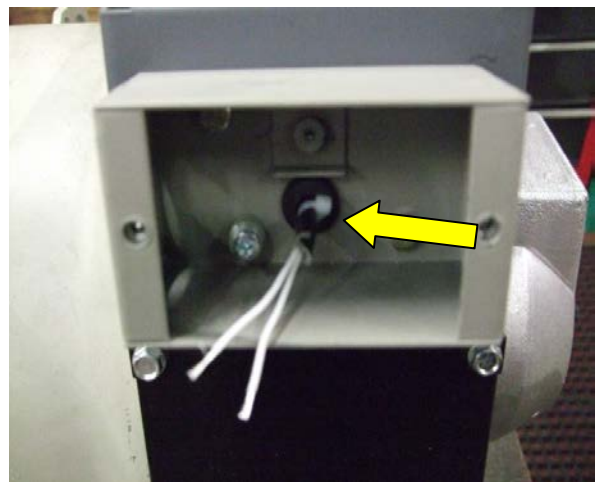

Insert the stripped lead ends into the terminal block and tighten the retaining screws ensuring that the contact is clamping onto conductor and not the insulator. Secure the terminal block using a M3X20 cheese head screw and spring washer.

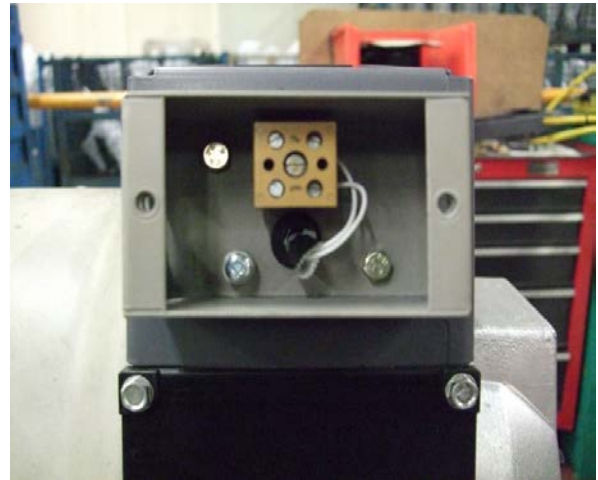

Fit a blind grommet to the cable entry side of the connection box.



Fit a label showing the heater voltage requirement to the position shown in connection box.



Position a Heater Electrical  
Warning “lightning” label, loose  
in the connection box.  
Secure the lid in position using  
the two screws supplied.

